

ANZZI™

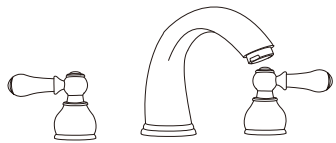

**L-AZ187BN
L-AZ187ORB**

**THREE HOLES BATHROOM VESSEL FAUCET
SOLID BRASS
CERAMIC CARTRIDGE
FLOW RATE:1.2GPM
LIMITED LIFETIME WARRANTY:**



**NSF/ANSI 61
NSF/ANSI 372**

HAVE QUESTIONS?

Call us at 1-844-44-ANZZI or visit www.ANZZI.com

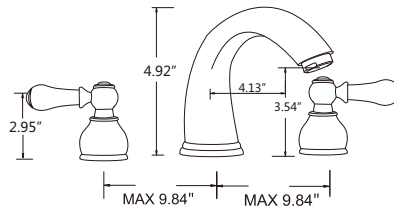

PREPARATION

MAKE SURE TO SHUT OFF THE WATER FLOW FROM YOUR HOT AND COLD SUPPLY LINES.

MAKE SURE YOUR MOUNTING HOLE IS CUT TO SIZE.

Make sure your counter is no more than 1.18" thick.

The mounting holes should be 1.38" in diameter.

The center of each hole no more than spaced 9.84" apart.



ITEMS YOU MAY NEED.

NEED HELP? Give us a call at 1-844-44-ANZZI or visit us online at www.ANZZI.com.

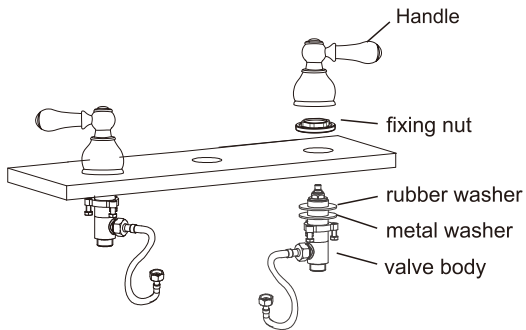

STEP 1

Handle installation

1. Disassemble the cold water handle.
2. From underneath, insert the cold water valve, rubber washer, metal washer and lock nut. From Top, install the handle and fixing nut.
3. Screw the nut to secure the valve.
4. Repeat steps to install hot water handle and hot water valve.

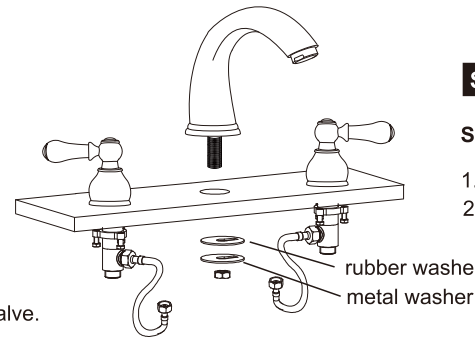

STEP 2

Spout installation

1. Disassemble the spout .
2. Place rubber washer, metal washer and nut in order and secure the nut.

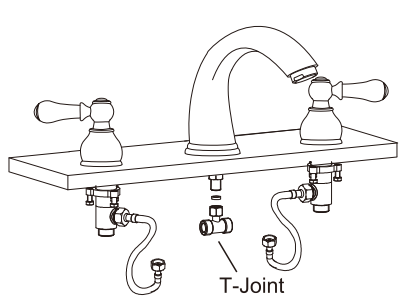

STEP 3

Connect and tighten the T-Joint to the shank.

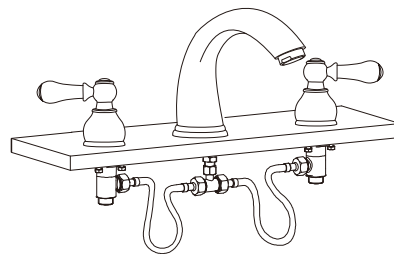

STEP 4

Connect hoses from valve body to the T-Joint .

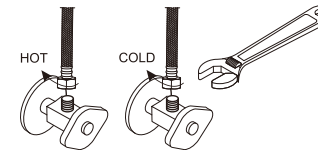

STEP 5

1. Connect the flexible hose(not included) to water supply valve (not included),and tighten it with adjustable wrench.

DON'T OVER TIGHTEN!

Caution: make sure to connect the hot and cold flexible hoses to supply valves correctly.

Warning:

Supply valves and flex hoses not included. Purchased separately.